

General Description

The TD75232 combines three drivers and five receivers, which conform to the EIA/TIA-232-F and ITU v.28 standards. Each receiver converts EIA/TIA-232-F inputs to 5-V TTL/CMOS levels and each driver converts TTL/CMOS input levels into EIA/TIA-232-F levels.

The flow-through pinout facilitates simple non-crossover board layout. The TD75232 provides a one-chip solution for the common 9-pin serial RS-232 interface between data terminal and data communications equipment. The TD75232 is available in SOIC-20, SSOP-20 and TSSOP-20 packages.

Features

- Single Chip with Easy Interface between UART and Serial-Port Connector
- Meet the Requirement of EIA/TIA-232-F and ITU v.28 Standards
- Designed to Support Data Rates up to 120kbit/s
- 3 Drivers and 5 Receivers
- Flow-through Pinout

Applications

- Mother Board
- Peripheral Equipment



SOIC-20



SSOP-20

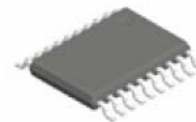

TSSOP-20

Package Types of TD75232

Pin Configuration

M/GS/G Package
(SOIC-20/SSOP-20/TSSOP-20)

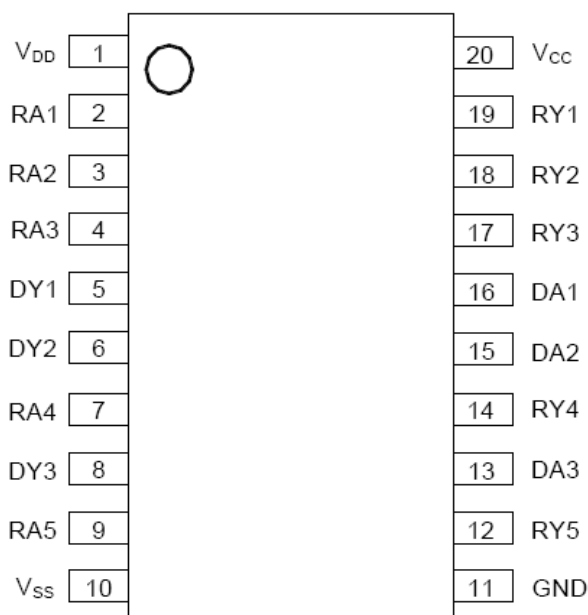

Pin Description

Pin Number	Pin Name	Function	Pin Number	Pin Name	Function
1	V _{DD}	Positive Supply Voltage for Driver	11	GND	Ground
2	RA1	Receiver Input	12	RY5	Receiver Output
3	RA2	Receiver Input	13	DA3	Driver Input
4	RA3	Receiver Input	14	RY4	Receiver Output
5	DY1	Driver Output	15	DA2	Driver Input
6	DY2	Driver Output	16	DA1	Driver Input
7	RA4	Receiver Input	17	RY3	Receiver Output
8	DY3	Driver Output	18	RY2	Receiver Output
9	RA5	Receiver Input	19	RY1	Receiver Output
10	V _{SS}	Negative Supply Voltage for Driver	20	V _{CC}	Supply Voltage for Receiver

Ordering Information

TD75232 □ □

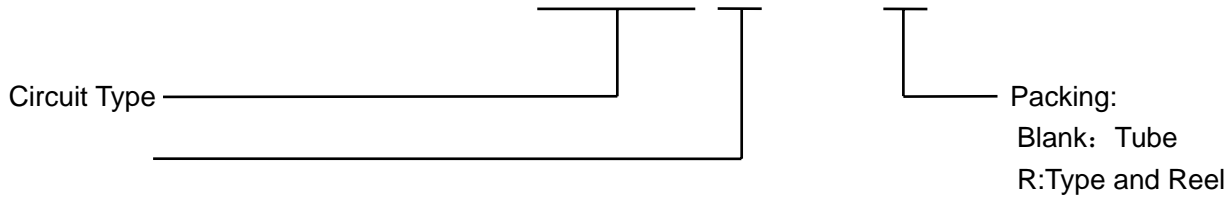

Package:
 P: SOP20
 O: TSSOP20
 G: SSOP20

Functional Block Diagram

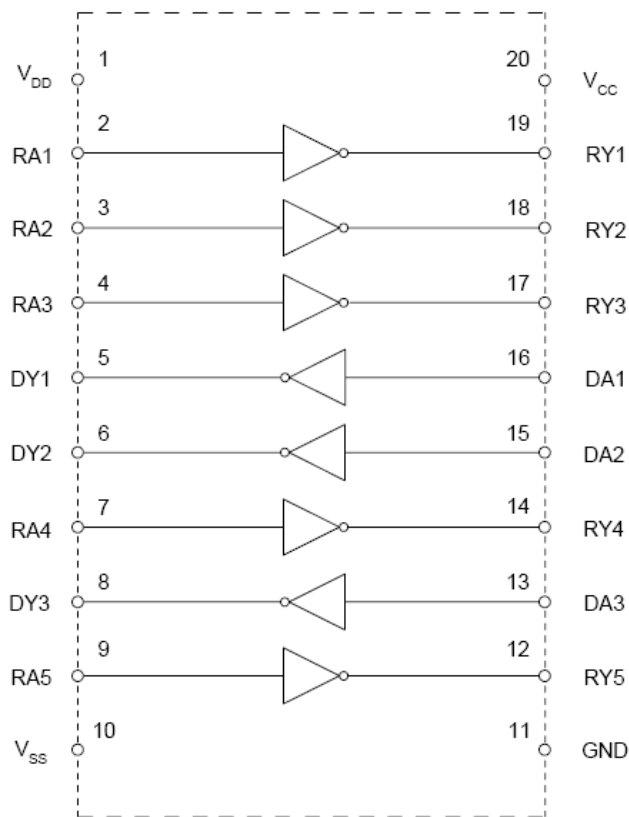

Functional Block Diagram of TD1722

Absolute Maximum Ratings

Parameter	Symbol	Value		Unit
Supply Voltage	V_{DD}	15		V
	V_{SS}	-15		
	V_{CC}	7		
Input Voltage Range	V_I	Driver	-15 to 7	V
		Receiver	-30 to 30	
Power Dissipation ($T_A=25^\circ\text{C}$)	P_D	SOIC-20	1340	mW
		SSOP-20	1210	
		TSSOP-20	1100	
Driver Output Voltage Range	V_O	-15 to 15		V
Receiver Low-Level Output Current	I_{OL}	20		mA
Operating Junction Temperature	T_J	150		$^\circ\text{C}$
Storage Temperature Range	T_{STG}	-65 to 150		$^\circ\text{C}$
Lead Temperature (Soldering, 10sec)	T_{LEAD}	260		$^\circ\text{C}$

Recommended Operating Conditions

Parameter	Symbol	Min	Max	Unit
Supply Voltage	V_{DD}	7.5	15	V
	V_{SS}	-15	-7.5	
	V_{CC}	4.5	5.5	
High-Level Input Voltage (Driver Only)	V_{IH}	1.9		V
Low-Level Input Voltage (Driver Only)	V_{IL}		0.8	V
High-Level Output Current	Driver		-6	mA
	Receiver		-0.5	
Low-Level Output Current	Driver		6	mA
	Receiver		16	
Operating Temperature Range	T_A	-40	85	$^\circ\text{C}$

Electrical Characteristics

Parameter	Symbol	Conditions	Min	Typ	Max	Unit
VOLTAGE SUPPLY SECTION ($V_{CC}=5V$, $V_{DD}=9V$, $V_{SS}=-9V$, unless otherwise specified)						
Supply Current from V_{DD}	I_{DD}	All inputs at 1.9V, no load	$V_{DD}=9V$, $V_{SS}=-9V$		15	mA
			$V_{DD}=12V$, $V_{SS}=-12V$		19	
			$V_{DD}=15V$, $V_{SS}=-15V$		25	
		All inputs at 0.8V, no load	$V_{DD}=9V$, $V_{SS}=-9V$		4.5	
			$V_{DD}=12V$, $V_{SS}=-12V$		5.5	
			$V_{DD}=15V$, $V_{SS}=-15V$		9	
Supply Current from V_{SS}	I_{SS}	All inputs at 1.9V, no load	$V_{DD}=9V$, $V_{SS}=-9V$		-15	mA
			$V_{DD}=12V$, $V_{SS}=-12V$		-19	
			$V_{DD}=15V$, $V_{SS}=-15V$		-25	
		All inputs at 0.8V, no load	$V_{DD}=9V$, $V_{SS}=-9V$		-3.2	
			$V_{DD}=12V$, $V_{SS}=-12V$		-3.2	
			$V_{DD}=15V$, $V_{SS}=-15V$		-3.2	
Supply Current from V_{CC}	I_{CC}	All inputs at 5V, no load, $V_{CC}=5V$			30	mA

DRIVER SECTION ($V_{CC}=5V$, $V_{DD}=9V$, $V_{SS}=-9V$, unless otherwise specified)						
High-Level Output Voltage	V_{OH}	$V_{IL}=0.8V$, $R_L=3k\Omega$	6	7.5		V
Low-Level Output Voltage	V_{OL}	$V_{IH}=1.9V$, $R_L=3k\Omega$		-7.5	-6	V
High-Level Input Current	I_{IH}	$V_I=5V$			10	μA
Low-Level Input Current	I_{IL}	$V_I=0V$			-1.6	mA
High-Level Short-Circuit Output Current	$I_{OS(H)}$	$V_{IL}=0.8V$, $V_O=0V$	-4.5	-12	-19.5	mA
Low-Level Short-Circuit Output Current	$I_{OS(L)}$	$V_{IH}=2V$, $V_O=0V$	4.5	12	19.5	mA
Output Resistance	r_O	$V_{CC}=V_{DD}=V_{SS}=0$, $V_O=-2V$ to $2V$	300			Ω

Electrical Characteristics(Cont.)

DRIVER SECTION ($V_{CC}=5V, V_{DD}=12V, V_{SS}=-12V$, unless otherwise specified)						
Propagation Delay Time Low to High Level Output	t_{PLH}	$R_L=3k\Omega$ to $7k\Omega, C_L=15pF$		315	500	ns
Propagation Delay Time High to Low Level Output	t_{PHL}	$R_L=3k\Omega$ to $7k\Omega, C_L=15pF$		75	175	ns
Transition Time Low to High Level Output	t_{TLH}	$R_L=3k\Omega$ to $7k\Omega$	$C_L=15pF$	60	100	ns
			$C_L=2500pF$ (Note 2)	1.7	2.5	μs
Transition Time High to Low Level Output	t_{THL}	$R_L=3k\Omega$ to $7k\Omega$	$C_L=15pF$	40	75	ns
			$C_L=2500pF$ (Note 2)	1.5	2.5	μs

RECEIVER SECTION ($V_{CC}=5V, V_{DD}=9V, V_{SS}=-9V$, unless otherwise specified)						
Positive-Going Input Thresh- old Voltage	V_{IT+}			1.75	1.9	2.3
		$T_A = -40$ to $85^\circ C$		1.55		2.3
Negative-Going Input Threshold Voltage	V_{IT-}			0.75	0.97	1.25
Input Hysteresis Voltage	V_{HYS}			0.5		V
High-Level Output Voltage	V_{OH}	$I_{OH}=-0.5mA$	$V_{IH}=0.75V$	2.6	4	5
			Input Open	2.6		
Low-Level Output Voltage	V_{OL}	$I_{OL}=10mA, V_I=3V$			0.2	0.45
High-Level Input Current	I_{IH}	$V_I=25V$		3.6		8.3
		$V_I=3V$		0.43		
Low-Level Input Current	I_{IL}	$V_I=-25V$		-3.6		-8.3
		$V_I=-3V$		-0.43		
Short-Circuit Output Current	I_{OS}	$V_I=0.8V$			-3.4	-12

RECEIVER SECTION ($V_{CC}=5V, V_{DD}=12V, V_{SS}=-12V$, unless otherwise specified)						
Propagation Delay Time Low to High Level Output	t_{PLH}	$R_L=5k\Omega, C_L=50pF$		105	250	ns
		$R_L=1.5k\Omega, C_L=15pF$		100	160	
Propagation Delay Time High to Low Level Output	t_{PHL}	$R_L=5k\Omega, C_L=50pF$		60	150	ns
		$R_L=1.5k\Omega, C_L=15pF$		42	100	
Transition Time Low to High Level Output	t_{TLH}	$R_L=5k\Omega, C_L=50pF$		170	350	ns
		$R_L=1.5k\Omega, C_L=15pF$		90	175	
Transition Time High to Low Level Output	t_{THL}	$R_L=5k\Omega, C_L=50pF$		16	60	ns
		$R_L=1.5k\Omega, C_L=15pF$		15	50	

Typical Operating Characteristics

Voltage Transfer Characteristics

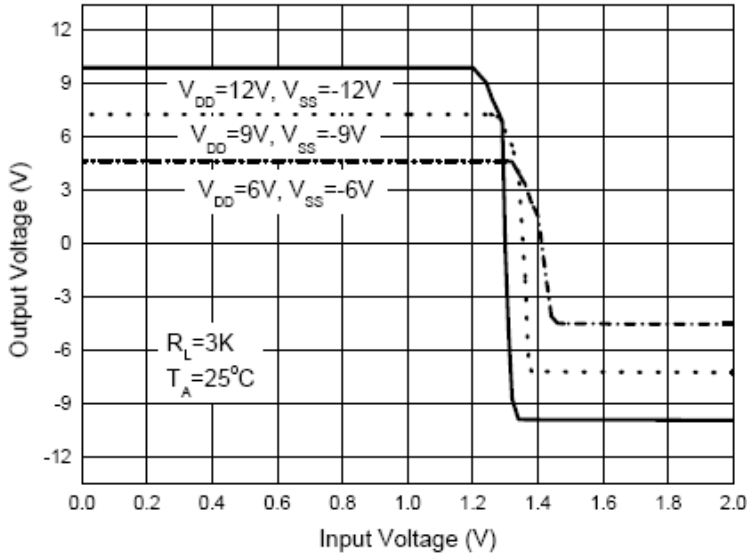

Output Current vs. Output Voltage

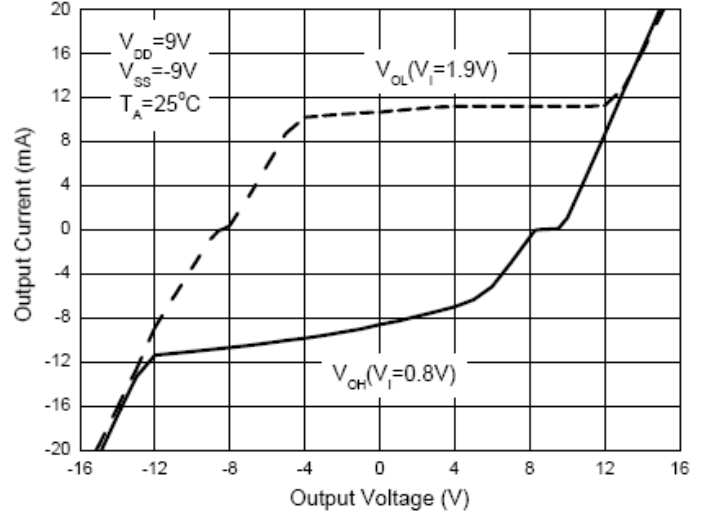

Short-Circuit Output Current vs. Temperature

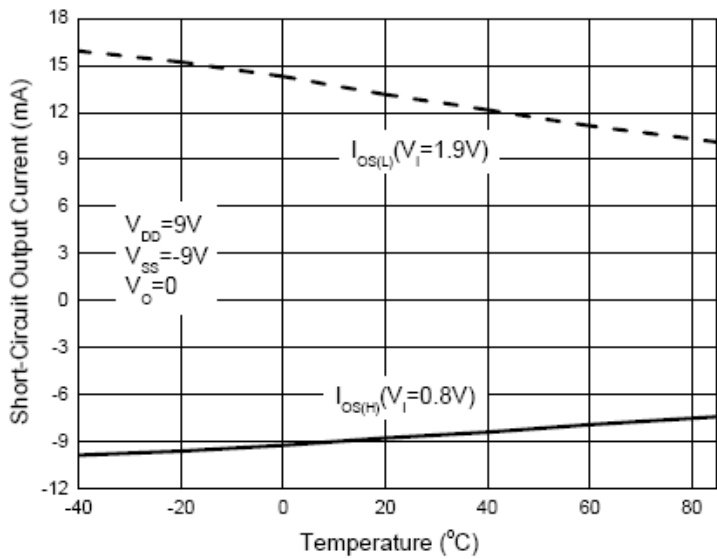

Slew Rate vs. Load Capacitance

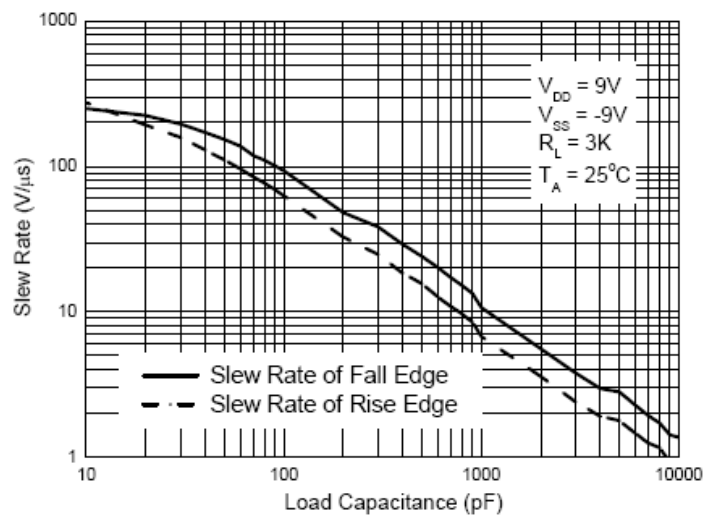

Typical Operating Characteristics(Cont.)

Input Threshold Voltage vs. Temperature

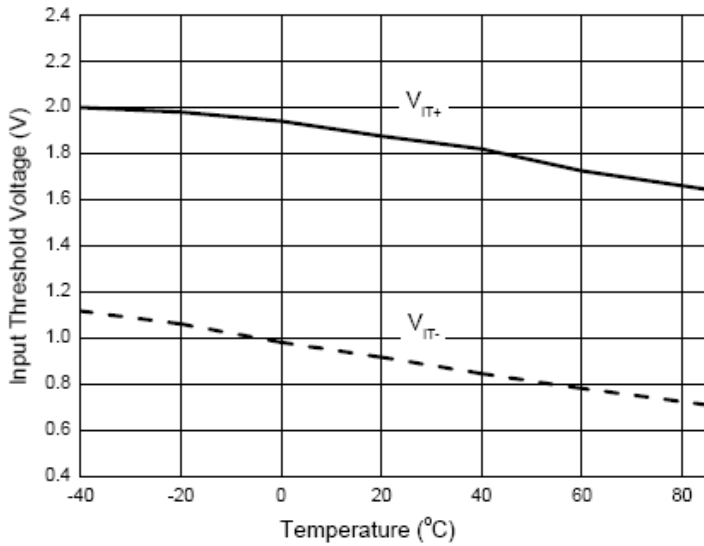

Input Threshold Voltage vs. Supply Voltage

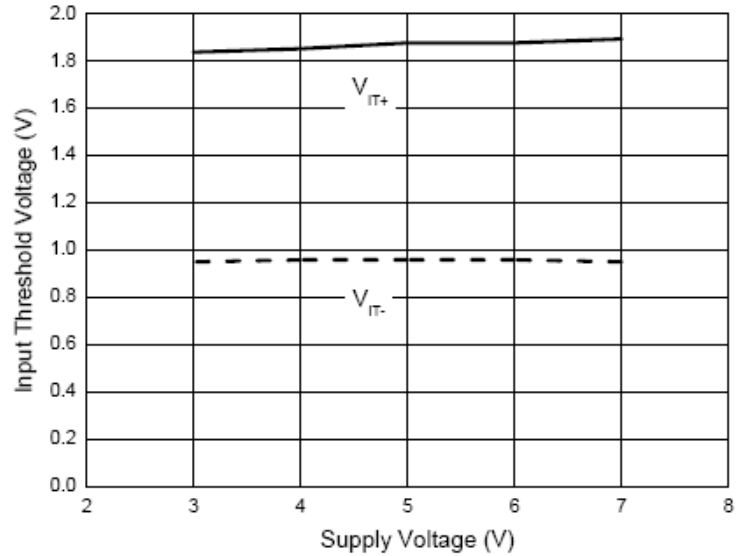

Noise Rejection

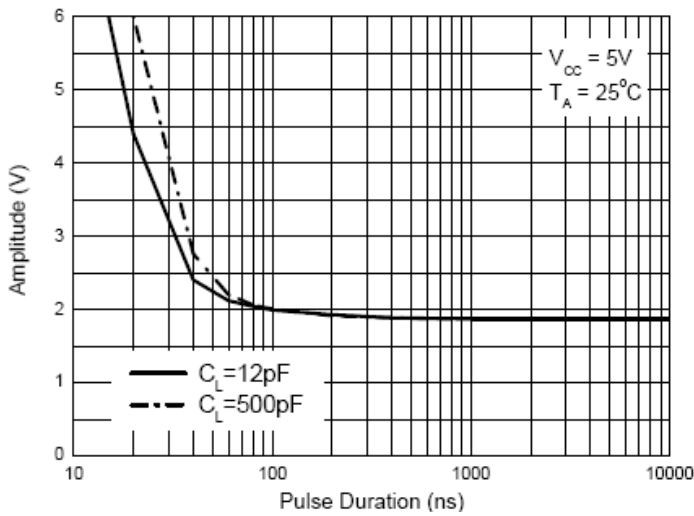

Typical Application Circuit

TD1722 B/C/D Application Circuit

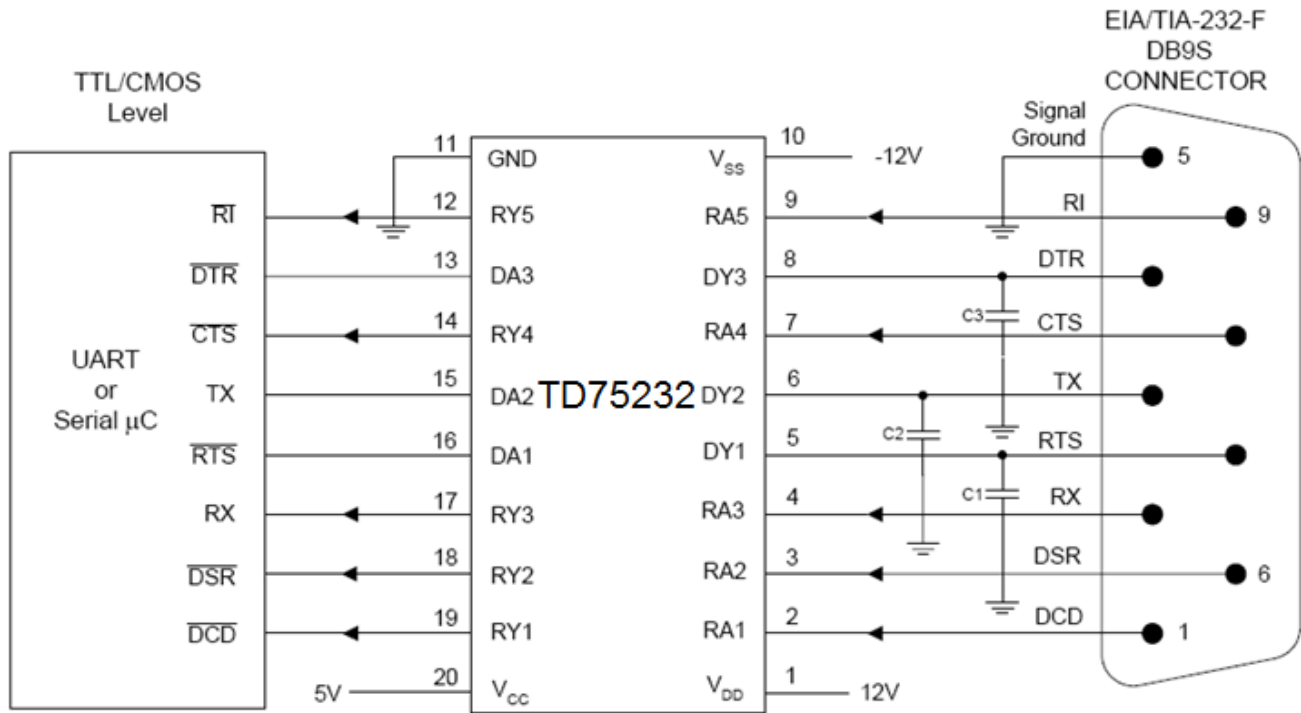

Package Information

SOP20 Package Outline Dimensions(Unit:inch)

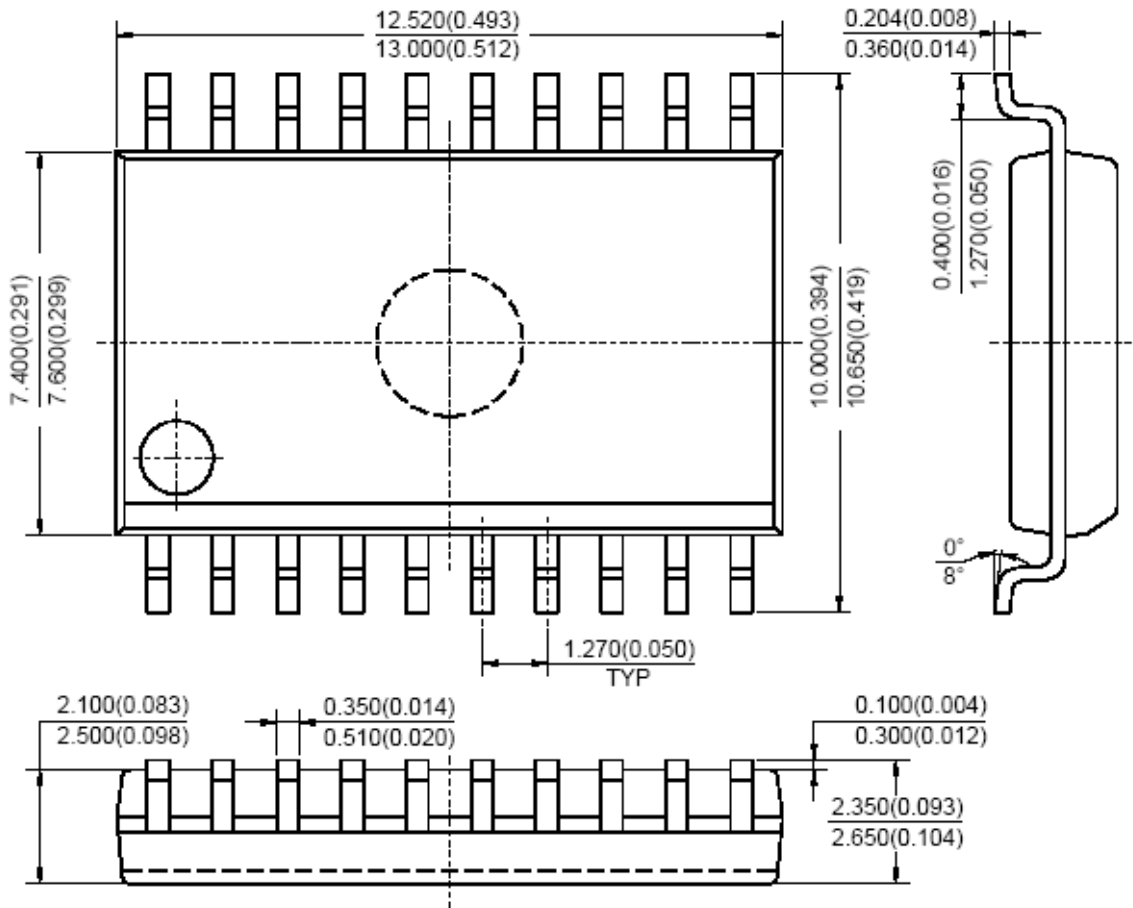

Package Information

SSOP20 Package Outline Dimensions(Unit:inch)

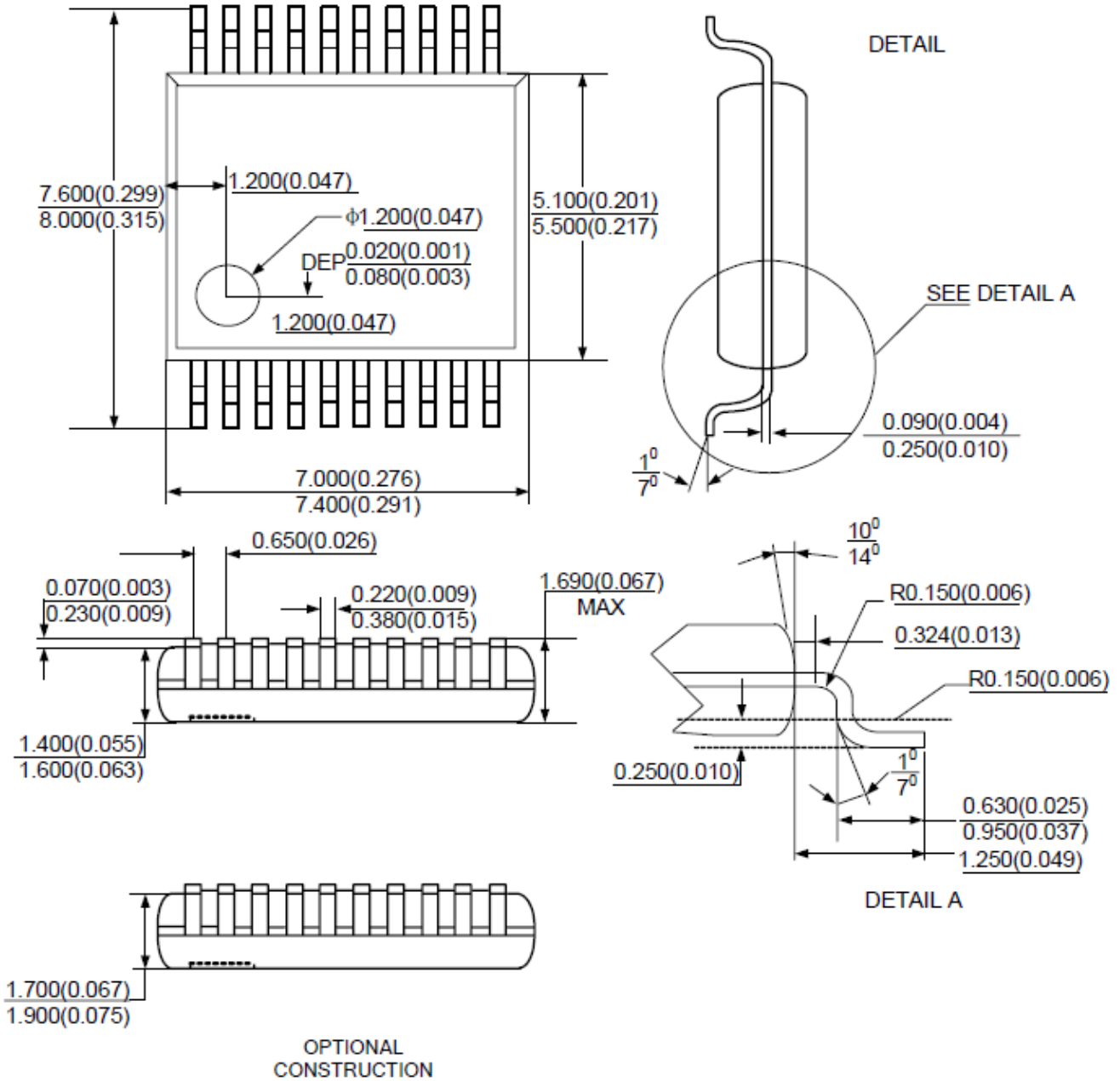

Design Notes